

American AP-33 Progressive Cavity Pump

Features

- * Low Cost
- * Low Shear
- * Solids Handling
- * Compact Design
- * Direct Motor Speeds
- * Gear Reduction Options

Pump Description

The American AP Progressive Cavity Wobble Stator Pump Series from Liberty Process Equipment offers the best value available on the pump market for a progressive cavity pump for flows up to 53 GPM and pressures up to 150 psi. The simple design of the wobble stator and just one universal joint give you the inherent advantages of a progressive cavity pump of low pulsation and shear, solids handling and viscous liquids at an affordable price.

The Long-Coupled and Close-Coupled Version is available in either Cast Iron or 316 Stainless Steel with standard Buna Nitrile Stator with options in Viton and EPDM and Stainless Internals with a hard-chrome plated rotor for long service life. In addition, the pump is available with a standard mechanical seal or can be upgraded to a hard-face mechanical seal for abrasion resistance. We also offer optional Gland Packing.

The American Pump Series is offered in a Long-Coupled design for mounting on a baseplate with a standard motor. All pumps are offered "off the shelf" from our inventory for immediate shipment.

Materials

Rotor: *Stainless Steel Chrome-Plated*

Stator: *Buna, Viton™, EPDM*

Motor: *3/4, 1, 1.5, and 2 hp*

Inlet: *3/4"*

Outlet: *3/4"*

Bases: *Steel or Stainless Steel*

Click To Visit www.libertyprocess.com >>

WWW

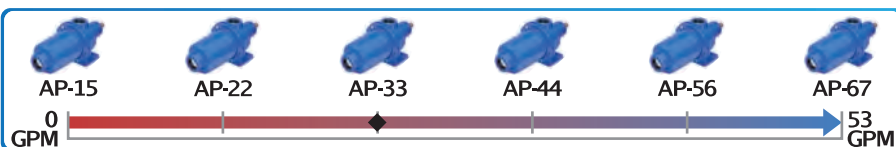

American AP-33

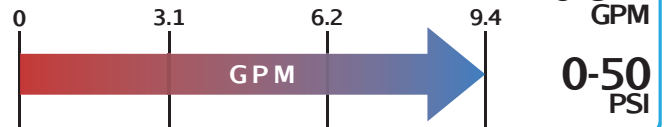

Curves



Please Click the Icon

Drawings

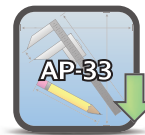

Please Click the Icon



Liberty Process Equipment, Inc.
2525 S Clearbrook Dr.
Arlington Heights, IL 60005-4623
P-(847) 640-7867
F-(847) 640-7855
sales@libertyprocess.com

American AP-33

Flow

Model AP-33

Test Liquid - Water @ 70°F

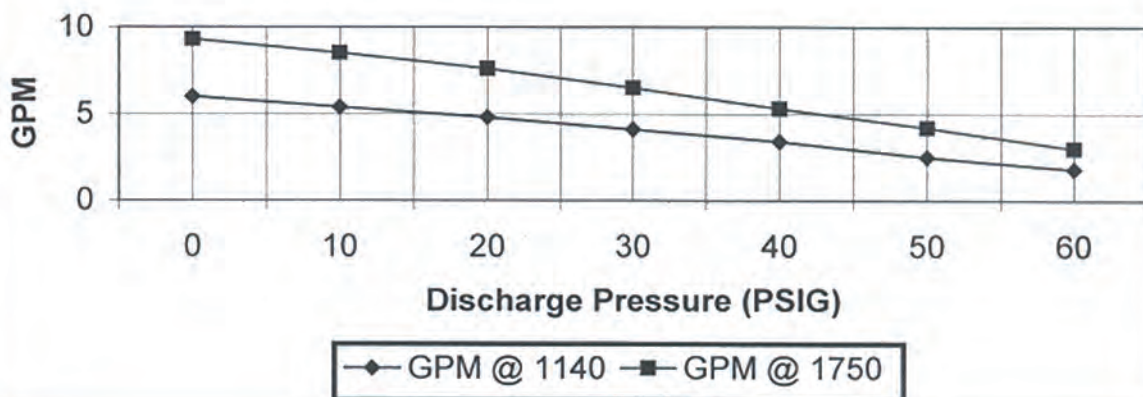

Horse Power

Model AP-33

Test Liquid - Water @ 70°F

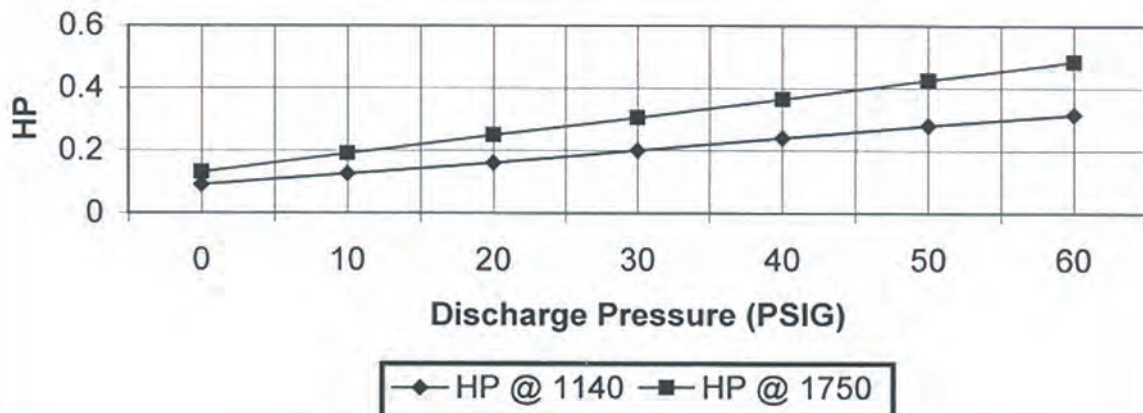

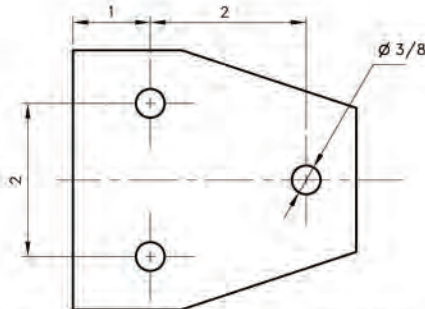
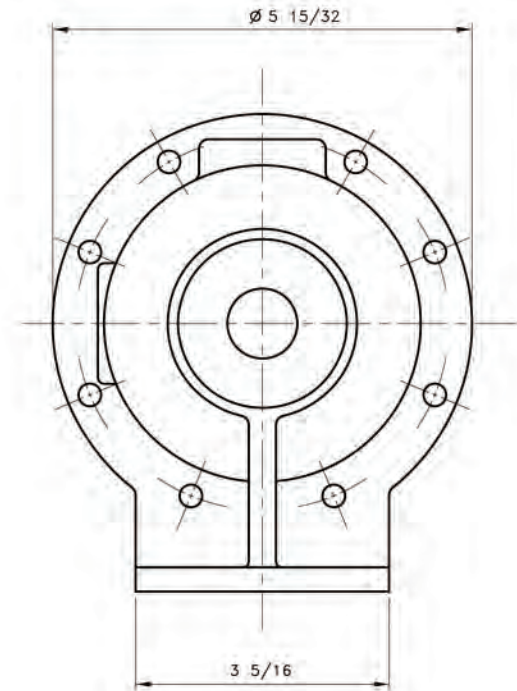
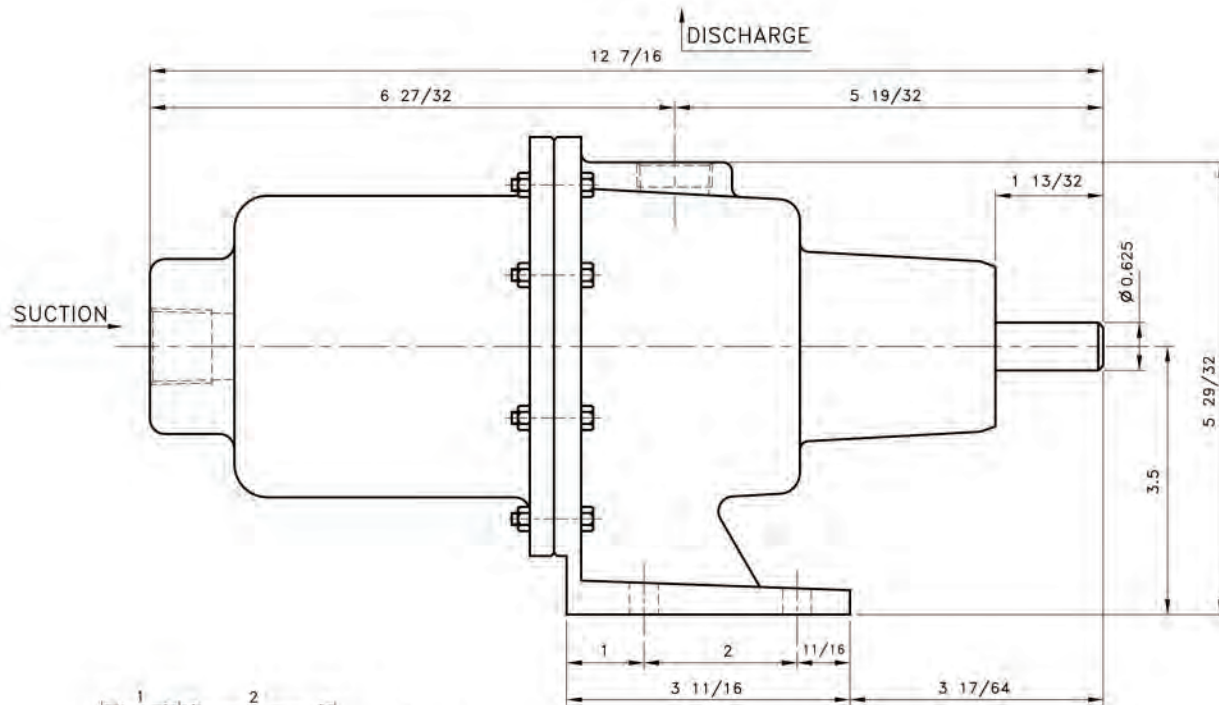

AP-15/22/33/44 SUPPORT BASE

ALL DIMN : INCH

AP-33



2525 S. Clearbrook Dr.
Arlington Heights, IL 60005
P: (847) 439-9200
F: (847) 439-9388

Manufacturer: Liberty Process

Pump Type: AP-33

Inlet Flange: 3/4" NPTF

Outlet Flange: 3/4" NPTF

Pump Housing: Cast Iron or SS

Rotor: SS Chrome-plated

Stator: Buna or Viton

Weight: 20 lbs.

Drain Opening (R1): 1/4 NPT

Shaft Diameter: 5/8"